

GENERAL INFORMATION

- Check local building codes before installation.
- Before proceeding, read all instructions for both Everlast siding and appropriate pocket trim products.
- Everlast Board & Batten siding is for vertical application only. Do NOT install horizontally.
- Do NOT install Everlast siding in temperatures below 0° F.
- Inspect siding for any breakage, foreign objects, surface defects, color consistency and correctness. Do NOT install questionable product.

JOB SITE STORAGE

- Do NOT stack siding more than 3 skids high.
- Do NOT store bundles in a vertical position.

BEST PRACTICE

- Siding should be stored inside when possible.
- Always avoid storing in direct sunlight, product should be covered and protected prior to installation using a tarp and/or supplied shroud. Keep siding away from heat sources.
- When product is stored outside use wood (or equivalent) supports to avoid direct contact with the ground in conjunction with covering.

PREPARING WALL SURFACES

- Everlast siding must be installed over flat and level exterior walls.
- Fastening into studs is not required, but Board & Batten must be installed into a minimum 7/16" of wood sheathing. The fasteners must penetrate beyond the wood sheathing a minimum of 3/4".
- For stud walls only with no wood substrate, apply 1" x 3" furring strips horizontally every 14" on center, or apply an OSB or plywood substrate over the studs.
- Everlast siding serves as a rain screen, not a weather-resistant barrier. Therefore, it must be installed over a weather-resistant barrier to eliminate any water penetration.
- Properly flash around all windows, doors, rake boards, chimneys, and areas of transition between dissimilar materials.
- If installing over concrete block, poured concrete, or brick, siding must be installed over 1" x 3" furring strips. Apply 1" x 3" wood furring strips horizontally 14" on center to create a level surface. If additional insulation is required, then apply rigid foam or fiber sheathing.

CREATING A BALANCED WALL

- It is not required to do so, but to create a balanced appearance on the the wall, use the following calculation.
- *Divide wall in inches by 10.875 (round down to whole number) = # of full panels needed. Multiply # of full panels needed by 10.875 = total coverage of full panels. Subtract total length of wall by total coverage of full panels = uncovered length. Divide uncovered length by 2 = each side piece reveal.*

*Example (125" wall)
 $125 / 10.875 = 11.49$ (round to 11)
 $11 \times 10.875 = 119.625$
 $125 - 119.625 = 5.375$
 $5.375 / 2 = 2.69$*

Note: Total wall length must be measured after the trim has been installed.

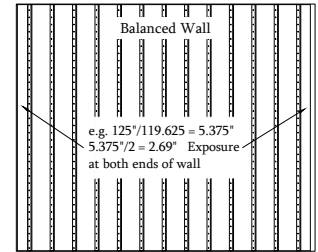
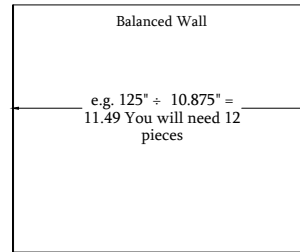

BEST PRACTICE

If exterior walls are not flat or level, a quality underlayment should be installed first to create a flat and level surface.

TRIM & ACCESSORIES

- Everlast Board & Batten requires the use of pocketed trim accessories. The siding cannot be butted up against trim.
- All current Everlast trim accessories are recommended for installation but not required. Everlast two-piece trim is recommended for ease of installation of the Board & Batten siding.
- The pocket or rabbeted trim accessories must be a minimum pocket width of 3/4" and depth of 5/8" to accommodate the panel interlock, as well as expansion and contraction.

CUTTING PANELS

- For horizontal cuts, use a power saw with a fine tooth (80T) finish plywood blade.
- An option for vertical cuts only, is to use a straight edge or metal brake with a utility knife or scoring tool. Score the face of the panel and then snap the panel on the score line.
- A circular saw can be used for vertical cuts as well.

REQUIRED FASTENERS

- Fasten panels only with aluminum, stainless steel, galvanized or other corrosion-resistant nails or screws.
- Nail/screw head diameter must be 3/8" to 7/16" with a maximum shank diameter of .160".
- If installing into metal framing, use self-tapping corrosion-resistant screws.
- Note: In high wind areas, screws or ring shank nails are recommended. Always consult with local building codes.

STARTING THE INSTALLATION

- Install pocketed trim at all inside and outside corners, around all windows and doors, and at the top termination of the Board & Batten siding. Make sure trim is installed level.
- The bottom can be flush with trim.
- Pocketed trim must have a minimum width of 3/4" to accommodate the batten of the panel.
- Everlast 2-piece perimeter trim requires the trim receiver to be installed prior to the Board & Batten siding. The 1-1/2" perimeter trim cover will be installed after siding installation is complete.
- If using rabbeted trim accessories, please follow manufacturers instructions for use. Properly measure and chalk a level line. Leave proper allowance for installation of the trim after the siding is installed.

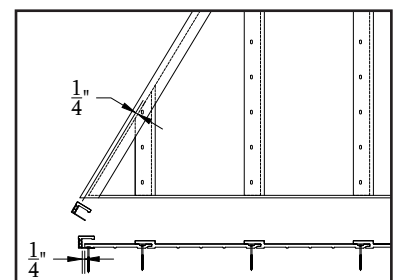
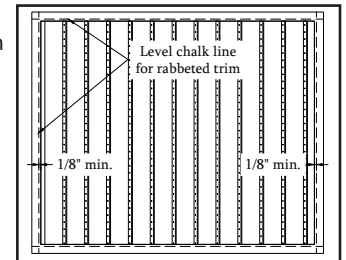

- If installing pocketed trim at the bottom of the course, it is recommended to drill 3/16" weep holes in the bottom of the channel every 18"-24" to allow for moisture to escape.
- To accommodate expansion and contraction, always leave a 1/4" gap between the siding panel and the inner wall of the top pocketed trim.

PROPER FASTENING

- Everlast is a floating siding system that accommodates vertical expansion and contraction within pocketed trim. Therefore, never hard nail siding panels tightly to the wall.
- The first fastener should be placed at the top of the bottom-most nail slot.
- Continue fastening at the top of the nail slot at intervals of every 3rd slot.
- Always fasten siding panels through the top of the pre-punched nailing slots.
- Always leave a minimum 1/32" gap between the fastener head and the nailing hem.
- Avoid fastening siding in a manner where it will conform to dips or bumps in the wall. On wavy walls, float the siding panels accordingly and shim where necessary to achieve visual flatness.

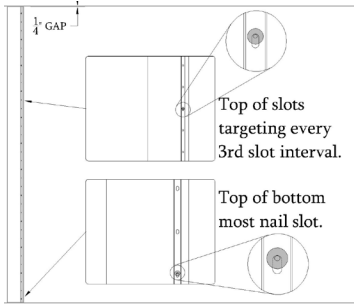

EXPANSION AND CONTRACTION

- With Everlast Board & Batten siding, allow for 1/4" of movement at the top of the panel when measuring.
- Position the first nail at the top of the bottom-most nail slot. This will help with letting the siding hang in place and allow the panels to rest at the bottom of trim.
- Center the remaining fasteners in the slots.

PANEL INSTALLATION

- Board & Batten panels can be installed in a left to right or right to left orientation.
- The nail hem will always be in the direction of installation.
- On each panel there is an **installation line guide** to ensure the panel is fully seated within the interlock. Always make sure this line is completely covered by the edge of the batten strip.
- The first panel will act as a starter strip for the entire course. This panel must be checked for perfect level prior to continuing the installation.

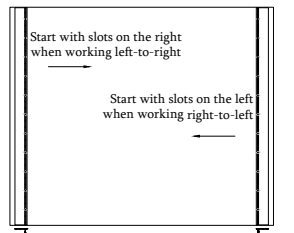

INSTALLING AROUND WINDOWS/DOORS/CUT OUTS

- When measuring Board & Batten panels to be cut and installed around windows, doors, and other cut outs, it is important to leave 1/4" gap on the top, bottom, and sides. This will maintain enough room for vertical expansion and contraction and ease of installation.

- It may be necessary to remove 1/8" from the interlock on the panel to be installed to allow the panel to slide into the trim, clear the existing panel, and have proper engagement. Use a utility blade to complete this task.

TRANSITIONING TO COURSES

- Board & Batten panels cannot be stacked on top of one another. *This is not a butt joint system.*
- If the wall is taller than one course (more than 12') it is important to separate the courses by a transition piece.
- The transition piece must be "Z flashed" prior to applying the second course of Board & Batten.
- When transitioning from horizontal siding to Board & Batten follow the same steps.
- Refer to "Starting the Installation" for second course installations.

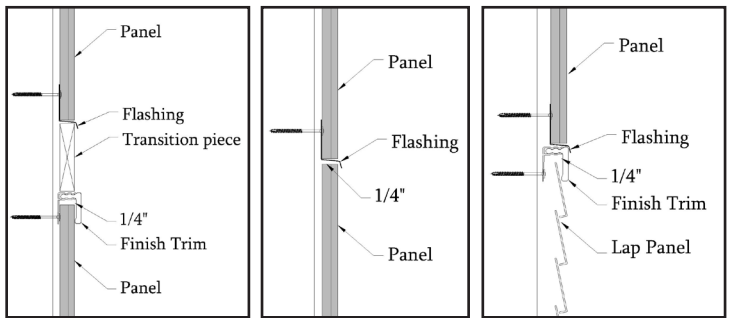

FINISHING THE LAST COURSE

- Finishing the last course may require you to remove part of the panel.
- Cut off 1/8" of the interlock to allow the panel to slide into the trim accessory and engage on the previous panel.
- Use a color-matched trim nail to fasten the last piece.
- Pre-drill a hole slightly larger than the shank of the fastener. Fasten every 16"-24" close to the end of the panel to hold in place.
- This is the only instance where the panels will need face fastened.
- If you choose to not face fasten the final panel, use a silicon adhesive on the inside of the interlock. Insert the last piece to lock the two panels together. The last two courses will move as one.

